

TOP VIEW

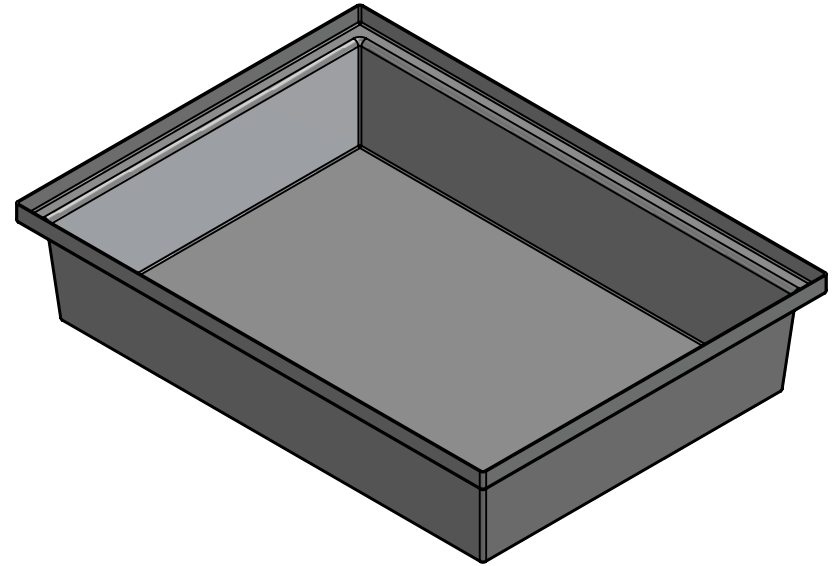

ISOMETRIC VIEW

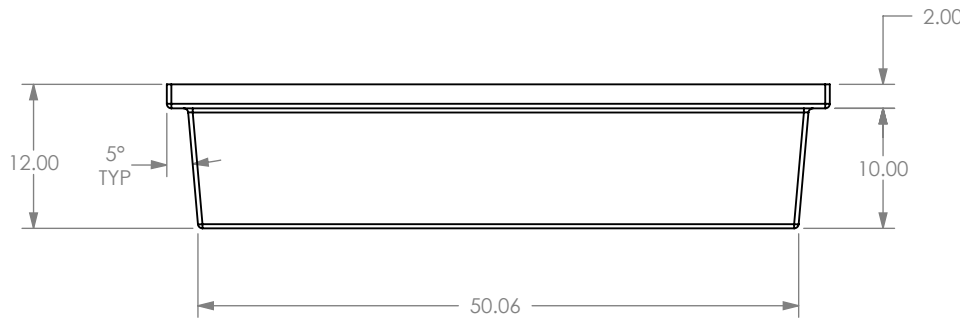

FRONT VIEW



SIDE VIEW

- Estimated Shot Weight @0.20 Wall Thickness: 27 lbs
- Estimated Part Gallonage @0.20 Wall Thickness: 90 Gallons

PROPRIETARY AND CONFIDENTIAL
 THE INFORMATION CONTAINED IN THIS DRAWING IS THE SOLE PROPERTY OF SHERMAN ROTO TANK, LLC. ANY REPRODUCTION IN PART OR AS A WHOLE WITHOUT THE WRITTEN PERMISSION OF SHERMAN ROTO TANK, LLC IS PROHIBITED.

UNLESS OTHERWISE SPECIFIED:
 DIMENSIONS ARE IN INCHES
 TOLERANCES:
 FRACTIONAL ±
 ANGULAR: MACH ± BEND ±
 TWO PLACE DECIMAL ±0.060
 THREE PLACE DECIMAL ±0.030

	NAME	DATE	SHERMAN ROTO TANK, LLC		
DRAWN	TN	07/07/14	TITLE: 90 Gallons Containment Basin		
CHECKED	DN	07/07/14			
ENG APPR.	TN	07/07/14	SIZE: A	DWG. NO. T000-40	REV: 0
MFG APPR.	WS	07/07/14	SCALE: 1:48	WEIGHT:	SHEET 1 OF 1
Q.A.	TN	07/07/14			